

# THÁI BÌNH DƯƠNG

## Lighting Company



THAI BINH DUONG Electric Co., Ltd  
2022 Catalogue

Tel: 0974.776.053

Email: [thuantrmt@gmail.com](mailto:thuantrmt@gmail.com)

Web: [www.denledthaiduong.vn](http://www.denledthaiduong.vn)

## COMPANY PROFILE

---

THAI BINH DƯƠNG Electric Co., Ltd is specialized in the development, production and marketing of commercial indoor lighting.

We have been serviced projects from VIET NAM. The products we manufacture include LED Recessed Spotlight, Downlight, Mini spotlight, Wall washer light, LED Grille Light, Trimless Downlight, Surface downlight, led track light and etc. The products are designed to save energy and promote environmental protection.

As a professional manufacturer, our R&D team have strong ability in handle highly customized designs and all kinds of OEM projects. We offer customer integrated service, including pre-sales service, after-sales service, technical support and transportation service.

We put the quality as priority, the success relies on the details, we hope to set up a long-term partnership with you through our high quality products.

## Factory Tour

---



## Workshop



## Testing instrument & Production equipment

---

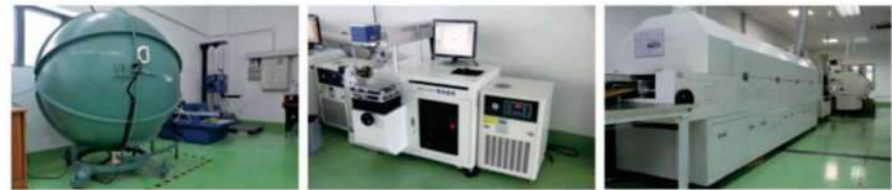

## COMPANY CULTURE

---

Honesty Culture: Honesty is the foundation of all, being the first rule of every action

Customer Culture: Nothing is important, but you!

Innovation Culture: Lighting the world through innovation!

Service Culture: Always here for you!

Responsibility Culture: Keep the world green, reduce power plant emissions, go LED today!



Item No.: FL1001-R  
Wattage: 10W  
Chip Led: Cree  
Driver: Lifud, CRI>90  
Beam Angle: 24°/38°  
CCT: 2700K/3000K/3500K/4000K

Size/Cut hole:  
Φ84\*58mm/Φ75mm  
Color: White/Black

Wattage: 10W  
Chip Led: Cree  
Driver: Lifud  
CRI>90  
Beam Angle: 24°/38°  
CCT: 2700K/3000K/3500K/4000K

Size/Cut hole:  
85\*85\*58mm/75\*75mm  
Color: White/Black

Item No.: FL1001-DS  
Wattage: 10W  
Chip Led: Cree  
Driver: Lifud  
CRI>90

Beam Angle: 24°/38°  
CCT: 2700K/3000K/3500K/4000K  
Size/Cut hole:  
85\*170\*58mm/75\*160mm  
Color: White/Black





Item No.: FL1002-S  
Wattage: 10W  
Chip Led: Cree  
Driver: Lifud  
CRI>90  
Beam Angle: 12°/24°/36°  
CCT: 2700K/3000K/3500K/4000K  
Size/Cut hole:  
85\*85\*63mm/75\*75mm  
Color: White/Red+Black/White



Item No.: FL1002-R  
Wattage: 10W  
Chip Led: Cree  
Driver: Lifud  
CRI>90  
Beam Angle: 12°/24°/36°  
CCT: 2700K/3000K/3500K/4000K  
Size/Cut hole:  
Φ85\*63mm/Φ75mm  
Color: White/Red+Black/White



Item No.: FL1002-DS  
Wattage: 2\*10W  
Chip Led: Cree  
Driver: Lifud  
CRI>90  
Beam Angle: 12°/24°/36°  
CCT: 2700K/3000K/3500K/4000K  
Size/Cut hole:  
85\*167\*63mm/75\*160mm  
Color: White/Red+Black/White





Item No.: FL1003  
Wattage: 5W/7W/12W  
Chip Led: Cree  
Driver: Lifud  
CRI>90  
Beam Angle: 15°/24°/38°  
CCT: 2700K/3000K/3500K/4000K  
Size/Cut hole:  $\Phi$ 60.5\*50mm/ $\Phi$ 55mm  
 $\Phi$ 80.5\*50mm/ $\Phi$ 55mm  
 $\Phi$ 100.5\*64mm/ $\Phi$ 95mm  
Color: White/Black+Chorme/Black/White





Item No.: FL1004  
Wattage: 5W/7W/15W  
Chip Led: Cree, CRI>90  
Driver: Lifud  
Beam Angle: 15°/24°/36°/60°  
CCT: 2700K/3000K/3500K/4000K  
Size/Cut hole:  
Φ60\*55mm/Φ55mm  
Φ80\*55mm/Φ75mm  
Φ100\*60mm/Φ95mm  
Color: White/Black







- Colour :
-  Sand gold
  -  Black
  -  Silver
  -  Chrome
- Optional :
-  Honey comb

Item No.: FL1005  
 Wattage: 9W/15W  
 Chip Led: Cree  
 Driver: Lifud  
 CRI>90  
 FIX Angle  
 Beam Angle: 15°/24°/36°  
 CCT: 2700K/3000K/3500K



**Fixed**

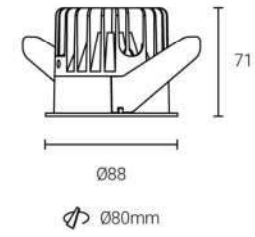
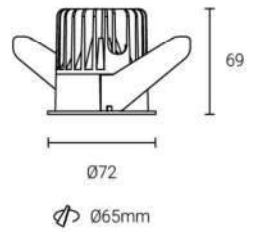

**Adjustable**

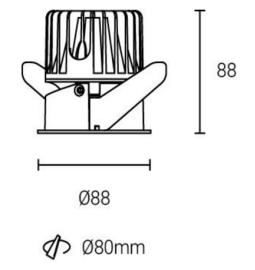
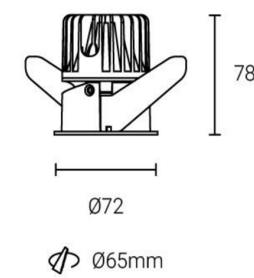



Item No.: FL1006  
Wattage: 7W/10W  
Chip Led: Cree  
Driver: Lifud  
CRI>90  
Beam Angle: 24°/38°  
CCT: 2700K/3000K/3500K/4000K  
Size/Cut hole:  
Φ75×60mm/55mm  
Φ84×78mm/75mm  
Color: White/Black/+ Rose Gold/Grey

- **Reliable Material:** Die-cast aluminum material not only guarantees corrosion protection and rust prevention, but improves the heat dissipation efficiency.
- **Perfect Illumination:** Deep anti-glare design provides sufficient light for general lighting without glare, bringing a cozy and warm ambiance for your sight.
- **Different reflectors:** Mirror reflector and frosted reflector for your option, aiming to meet different requests in the market.
- **Large wattage:** External constant current isolated driver, easily connected by male and female plugs, releases the limit of wattage. High brightness in high ceiling also creates a cozy atmosphere for your lobby.







Item No.: FL1007  
Wattage: 7W/12W/18W/24W  
Beam Angle: 15°/30°/45°  
Chip Led: Cree  
Driver: Lifud  
CRI>90  
CCT: 2700K/3000K/3500K/4000K  
Size/Cut hole:  
Φ70\*55mm/Φ60mm  
Φ95\*75mm/Φ80mm  
Φ120\*95mm/100mm  
Φ140\*105mm/Φ120mm  
Color: **White/Black +Chrome/White**

- Ultra-thin edge design: Rapidly integrates with the surrounding environment, making it difficult to find the connection between the lamp and the ceiling.
- Perfect Illumination: Deep anti-glare design provide sufficient light for general lighting without glare, bring a cozy and warm ambiance for your sight.
- Modular design: different surface rings for your option. You can DIY the appearance of your lamp whenever you like. What' s more, it will reduce your inventory to reduce risk.
- Reliable Safety: Die-cast aluminum material guarantees corrosion protection and rust prevention. The airtight structure ensure a long-lasting and stable lighting performance .





Item No.: FL1008-R  
Wattage: 7W/12W/18W/28W  
Beam Angle: 15°/24°/38°/60°  
CCT: 2700K/3000K/3500K/4000K  
Chip Led: Cree  
Driver: Lifud  
CRI>90, **FIX Angle**  
Size/Cut hole:  
Φ85\*68mm/Φ75mm  
Φ100\*87mm/Φ90mm  
Φ140\*105mm/Φ125mm  
Φ175\*115mm/Φ150mm



Item No.: FL1008-S  
Wattage: 7W/12W/18W/28W  
Beam Angle: 15°/24°/38°/60°  
Chip Led: Cree  
Driver: Lifud  
CRI>90, **FIX Angle**  
CCT: 2700K/3000K/3500K/4000K  
Size/Cut hole:  
85\*85\*68mm/75\*75mm  
100\*100\*87mm/90\*90mm  
140\*140\*105mm/125\*125mm  
175\*175\*115mm/150\*150mm

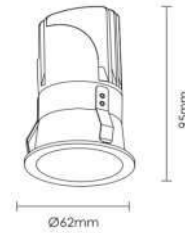

Item No.: FL1009  
 Wattage: 7W  
 Chip Led: Cree  
 Driver: Lifud  
 CRI>90  
 Beam Angle: 15°/24°/38°/60°  
 CCT: 2700K/3000K/3500K/4000K  
 Size/Cut hole:  
 Φ62\*90mm/Φ55mm



Item No.: FL1009  
 Wattage: 12W/15W  
 Chip Led: Cree  
 Driver: Lifud  
 CRI>90  
 Beam Angle: 15°/24°/38°/60°  
 CCT: 2700K/3000K/3500K/4000K  
 Size/Cut hole:  
 Φ82\*105mm/Φ75mm  
 Φ82\*105mm/Φ75mm

- **Reliable Material:**Die-cast aluminum material not only guarantees corrosion protection and rust prevention, but improves the heat dissipation efficiency.
- **Perfect Illumination:** Deep anti-glare design provide sufficient light for general lighting without glare, bring a cozy and warm ambiance for your sight.
- **large wattage:** External constant current isolated driver, easily connected by male and female plugs, release the limit of wattage. high brightness in high ceiling also creates a cozy atmosphere for your lobby



Picture



Item No.

FL1010

FL1010

FL1010

Wattage

5W

9W

15W

Chip Led

Cree

Cree

Cree

Driver

Lifud

Lifud

Lifud

Size

Φ40\*58mm

Φ60\*H82mm

Φ75\*100mm

Cut Hole

Φ35mm

Φ55mm

Φ70mm

Beam Angle

24°/36°

20°/40°

24°/38°

CRI

>90

>90

>90

Drawing

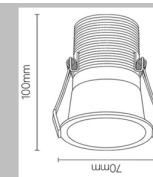
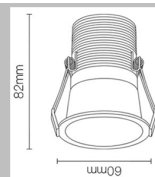

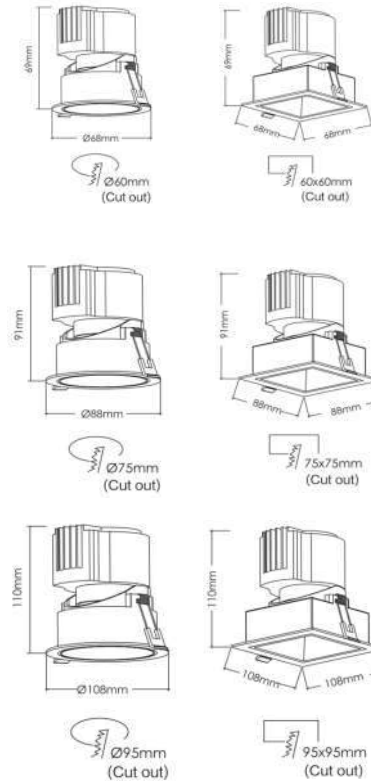

Item No.: FL1011  
 Wattage: 7W/12W/18W  
 Beam Angle: 15/24/38°  
 Chip Led: Cree, CRI>90  
 Driver: Lifud  
 CCT: 2700K/3000K/3500K  
 Size/Cut hole:  
 Φ68\*69mm/Φ60mm  
 Φ88\*91mm/Φ75mm  
 Φ108\*110mm/Φ95mm

Item No.: FL1011  
 Wattage: 7W/12W/18W  
 Beam Angle: 15/24/38°  
 Chip Led: Cree, CRI>90  
 Driver: Lifud  
 CCT: 2700K/3000K/3500K  
 Size/Cut hole:  
 68\*68\*69mm/60\*60mm  
 88\*88\*91mm/75\*75mm  
 108\*108\*110mm/95\*95mm

- **Reliable Material:** Die-cast aluminum material not only guarantees corrosion protection and rust prevention, but improves the heat dissipation efficiency.
- **Perfect Illumination:** Deep anti-glare design provide sufficient light for general lighting without glare, bring a cozy and warm ambiance for your sight.
- **Different reflectors:** Mirror reflector and frosted reflector for your option, aiming at meet different request in the market.



Picture



Item No.	FL1012	FL1012	FL1012	FL1012
Wattage	7W	12W	20W	30W
Chip Led	Cree	Cree	Cree	Cree
Driver	Lifud	Lifud	Lifud	Lifud

Size	Φ90*68mm	Φ110*78mm	Φ140*88mm	Φ160*90mm
------	----------	-----------	-----------	-----------

Cut Hole	Φ80mm	Φ95mm	Φ125mm	Φ145mm
----------	-------	-------	--------	--------

Beam Angle	15°/24°/38°/60°	15°/24°/38°/60°	15°/24°/38°/60°	15°/24°/38°/60°
------------	-----------------	-----------------	-----------------	-----------------

CRI	>90	>90	>90	>90
-----	-----	-----	-----	-----

Drawing

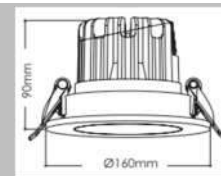
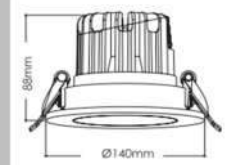
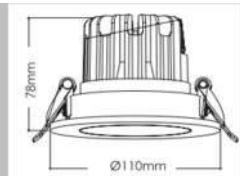
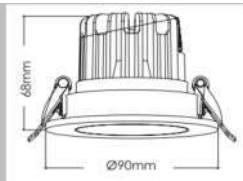



Picture



Item No.	FL1013	FL1013	FL1013	FL1013	FL1013
Wattage	1W	3W	5W	7W	12W
Chip Led	Cree	Cree	Cree	Cree	Cree
Driver	Lifud	Lifud	Lifud	Lifud	Lifud
Size	Φ30*24mm	Φ40*30.8mm	Φ55*51.4mm	Φ65*61.7mm	Φ75*70mm
Cut Hole	Φ25mm	Φ35mm	Φ50mm	Φ60mm	Φ70mm
Beam Angle	15°/27°/60°	15°/25°/50°	8°/25°/45°	20°/45°	15°/24°/36°
CRI	>90	>90	>90	>90	>90

Drawing

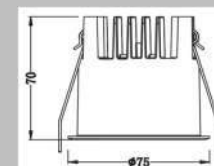
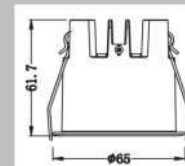
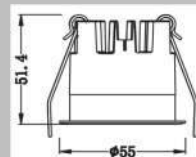
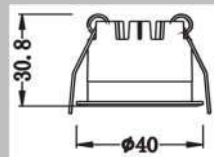
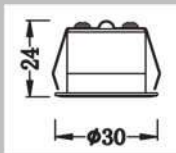



Item No.: FL1014-R  
 Wattage: 7W/12W/18W/28W/35W  
 Beam Angle: 15°/24°/38°  
 Chip Led: Cree  
 Driver: Lifud  
 CRI>90  
 CCT: 2700K/3000K/3500K/4000K  
 Size/Cut hole:  
 Φ68\*80mm/Φ55mm  
 Φ84\*105mm/Φ75mm  
 Φ110\*131.5mm/Φ95mm  
 Φ142\*153mm/Φ125mm  
 Φ165\*178mm/Φ150mm

Item No.: FL1014-S  
 Wattage: 7W/12W/18W/28W/35W  
 Beam Angle: 15°/24°/38°  
 Chip Led: Cree  
 Driver: Lifud  
 CRI>90  
 CCT: 2700K/3000K/3500K/4000K  
 Size/Cut hole:  
 68\*68\*80mm/55\*55mm  
 84\*84\*105mm/75\*75mm  
 110\*110\*131.5mm/95\*95mm  
 142\*142\*153mm/125\*125mm  
 165\*165\*178mm/150\*150mm



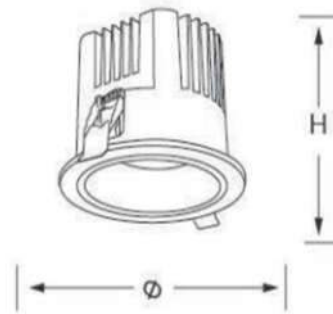

Item No.: FL1015  
Wattage: 10W/18W/30W  
Beam Angle: 15°/24°/38°/60°  
CCT: 2700K/3000K/3500K/4000K  
Chip Led: Cree  
Driver: Lifud  
CRI > 90  
Size/Cut hole:  
Φ85\*70mm/Φ75mm  
Φ108\*85mm/Φ95mm  
Φ135\*97mm/Φ125mm

- **Reliable Material:** Die-cast aluminum material not only guarantees corrosion protection and rust prevention, but improves the heat dissipation efficiency.
- **Perfect Illumination:** Deep anti-glare design provide sufficient light for general lighting without glare, bring a cozy and warm ambiance for your sight.
- **Different reflectors:** Mirror reflector and frosted reflector for your option, aiming at meet different request in the market.





Item No.: FL1016-R  
Wattage: 7W/12W/18W  
Beam Angle: 15°/25°/35°/50°  
Chip Led: Cree  
Driver: Lifud  
CRI>90  
CCT: 2700K/3000K/3500K/4000K  
Size/Cut hole:  
Φ65\*91mm/Φ55mm  
Φ86\*106mm/Φ75mm  
Φ113\*134mm/Φ100mm  
Color: White/Black+ Chrome/Bright Black

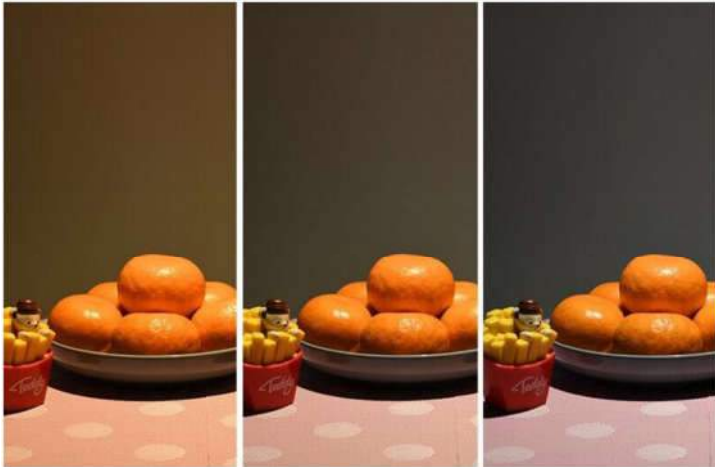

3000K

3500K

4000K



Item No.: FL1016-S  
Wattage: 7W/12W/18W  
Beam Angle: 15°/25°/35°/50°  
Chip Led: Cree  
Driver: Lifud  
CRI>90  
CCT: 2700K/3000K/3500K/4000K  
Size/Cut hole:  
65\*965\*91mm/55\*55mm  
86\*86\*106mm/75\*75mm  
1113\*13\*134mm/100\*100mm  
Color: White/Black+ Chrome/Bright Black



Item No.: FL1017  
Wattage: 7W/12W/18W  
Chip Led: Osram  
Beam Angle: 15°/24°/38°  
Chip Led: Cree  
Driver: Lifud  
CRI > 90  
CCT: 2700K/3000K/3500K/4000K  
Size/Cut hole:  
Φ85\*80mm/Φ75mm  
Φ104\*108mm/Φ95mm  
Φ132\*127mm/Φ125mm  
Color: White/Black+ Chrome/Bright Black





Item No.: FL1018-R  
Wattage: 10W/15W/25W  
Beam Angle: 15°/24°/38°  
CCT: 2700K/3000K/3500K/4000K  
Chip Led: Cree, Driver: Lifud, CRI>90  
Size/Cut hole:  
Φ64\*59mm/Φ55mm  
Φ86\*78mm/Φ75mm  
Φ106\*92mm/Φ95mm  
Color: White/Black+ Chrome/Bright Black



Item No.: FL1018-S  
Wattage: 10W/15W/25W  
Beam Angle: 15°/24°/38°  
Chip Led: Cree, Driver: Lifud, CRI>90  
CCT: 2700K/3000K/3500K/4000K  
Size/Cut hole:  
64\*64\*59mm/55\*55mm  
86\*86\*78mm/75\*75mm  
106\*106\*92mm/95\*95mm  
Color: White/Black+ Chrome/Bright Black



**INSTALLATION**



**01**



**02**

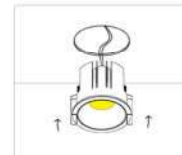

**03**

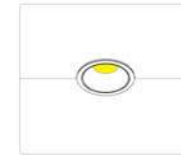

**04**





Item No.: FL1019  
Wattage: 7W/12W/18W  
Chip Led: Cree  
Driver: Lifud  
CRI>90  
Beam Angle: 15°/24°/36°  
CCT: 2700K/3000K/3500K/4000K  
Size/Cut hole:  
Φ62\*55mm/Φ55mm  
Φ85\*70mm/Φ75mm  
Φ105\*85mm/Φ95mm

- **Reliable Safety:** Aluminum material guarantees corrosion protection and rust prevention. The airtight structure ensure a long-lasting and stable lighting performance.
- **Cost-saving:** Photoelectric integration design, simplify structure to reduce useless costs.
- **Long lifespan:** aluminum alloy housing for better dissipation for longevity up to 20000 hours . High performance, modern round design apply to different commercial lighting area.



**LED Recessed Spotlight**



Item No.: FL1020-A  
 Wattage: 10W  
 Chip Led: Cree  
 Driver: Lifud  
 CRI>90  
 Beam Angle: 15°/24°/38°  
 CCT: 2700K/3000K/3500K/4000K  
 Size/Cut hole:  
 Φ90\*50mm/75mm  
 Color: White/Black+ White/Black

- CRI > 90
- UGR < 19
- No flickering
- 2700K
- 3000K
- 3500K
- 4000K
- Triac
- 0-10V
- DALI



Item No.: FL1020-B  
 Wattage: 10W  
 Chip Led: Cree  
 Driver: Lifud  
 CRI>90  
 Beam Angle: 15°/24°/38°  
 CCT: 2700K/3000K/3500K/4000K  
 Size/Cut hole:  
 Φ90\*60mm/75mm  
 Color: White/Black+ White/Black

- CRI > 90
- UGR < 19
- No flickering
- 2700K
- 3000K
- 3500K
- 4000K
- Triac
- 0-10V
- DALI



Item No.: FL1020-C  
 Wattage: 10W  
 Chip Led: Cree  
 Driver: Lifud  
 CRI>90  
 Beam Angle: 15°/24°/38°  
 CCT: 2700K/3000K/3500K/4000K  
 Size/Cut hole:  
 Φ90\*85mm/75mm  
 Color: White/Black+ White/Black

- CRI > 90
- UGR < 19
- No flickering
- 2700K
- 3000K
- 3500K
- 4000K
- Triac
- 0-10V
- DALI



Item No.: FL1020-D  
 Wattage: 10W  
 Chip Led: Cree  
 Driver: Lifud  
 CRI>90  
 Beam Angle: 15°/24°/38°  
 CCT: 2700K/3000K/3500K/4000K  
 Size/Cut hole:  
 Φ85\*70mm/75mm  
 Color: White/Black+ White/Black

- CRI > 90
- UGR < 19
- No flickering
- 2700K
- 3000K
- 3500K
- 4000K
- Triac
- 0-10V
- DALI

**LED Recessed Spotlight**



Item No.: FL1021  
 Wattage: 7W/12W/18W  
 Chip Led: Cree  
 Driver: Lifud  
 CRI>90  
 Beam Angle: 15°/24°/38°  
 CCT: 2700K/3000K/3500K/4000K  
 Size/Cut hole:  
 Φ71\*50mm/Φ60mm  
 Φ82\*58.5mm/Φ75mm  
 Φ101\*66mm/Φ95mm  
 Color: White/Black+ Chrome/Bright Black



Item No.: FL1022  
 Wattage: 5W/9W/12W  
 Chip Led: Cree  
 Driver: Lifud  
 CRI>90  
 Beam Angle: 24°/38°  
 CCT: 2700K/3000K/3500K/4000K  
 Size/Cut hole:  
 Φ62\*65mm/Φ55mm  
 Φ72\*77mm/Φ65mm  
 Φ82\*80mm/Φ75mm  
 Color: White/Black



Item No.: FL1023  
 Wattage: 9W/15W/20W/30W/35W  
 Chip Led: Cree, Driver: Lifud,  
 CRI>90  
 Beam Angle: 18°/26°/38°/55°  
 CCT: 2700K/3000K/3500K/4000K  
 Size/Cut hole:  
 Φ86\*115mm/Φ75mm  
 Φ110\*140mm/Φ100mm  
 Φ140\*155mm/Φ130mm  
 Φ168\*200mm/Φ155mm  
 Φ198\*210mm/Φ185mm



Item No.: FL1024  
 Wattage: 5W/7W/10W  
 Chip Led: Cree, Driver: Lifud,  
 CRI>90  
 Beam Angle: 15°/24°/38°  
 CCT: 2700K/3000K/3500K/4000K  
 Size/Cut hole:  
 Φ60\*60mm/Φ55mm  
 Φ70\*65mm/Φ65mm  
 Φ80\*70mm/Φ75mm  
 Color: White/Black+  
 Chrome/Bright Black





Item No.: FL1025  
 Wattage: 5W/7W/12W/18W  
 Chip Led: Cree  
 Driver: Lifud  
 CRI>90  
 Beam Angle: 15°/24°/38°/60°  
 CCT: 2700K/3000K/3500K/4000K  
 Size/Cut hole:  
 Φ60\*60mm/Φ50mm  
 Φ70\*65mm/Φ60mm  
 Φ85\*75mm/Φ75mm  
 Φ95\*85mm/Φ85mm



Item No.: FL1026  
 Wattage: 5W/7W/12W/18W  
 Chip Led: Cree  
 Driver: Lifud  
 CRI>90  
 Beam Angle: 60°  
 CCT: 2700K/3000K/3500K/4000K  
 Size/Cut hole:  
 Φ60\*60mm/Φ50mm  
 Φ70\*65mm/Φ60mm  
 Φ85\*75mm/Φ75mm  
 Φ95\*85mm/Φ85mm



Item No.: FL1027-SMD  
 Wattage: 7W/12W/18W  
 Chip Led: Cree  
 Driver: Lifud  
 CRI>90  
 Beam Angle: 60°  
 CCT: 2700K/3000K/3500K/4000K  
 Size/Cut hole:  
 Φ75\*55mm/Φ60mm  
 Φ88\*65mm/Φ75mm  
 Φ95\*75mm/Φ85mm



Item No.: FL1028  
 Wattage: 5W/9W/12W/18W  
 Beam Angle: 15°/24°/36°  
 Chip Led: Cree  
 Driver: Lifud  
 CRI>90  
 CCT: 2700K/3000K/3500K/4000K  
 Size/Cut hole:  
 Φ60\*40mm/Φ55mm  
 Φ70\*40mm/Φ60mm  
 Φ80\*40mm/Φ72mm  
 Φ100\*40mm/Φ92mm





Item No.: FL1029-R  
Wattage: 10W  
Chip Led: Cree  
Driver: Lifud  
CRI>90  
Beam Angle: 15°/24°/36°  
CCT: 2700K/3000K/3500K/4000K  
Size/Cut hole:  
Φ85\*H65mm/Φ75mm



**LED Recessed Downlight**



Item No.: FL2001-R  
Wattage: 9W, Driver: Lifud  
Chip Led: Osram, CRI>90  
Beam Angle: 110°  
Size/Cut hole:  
Φ110\*50mm/Φ100mm  
Color: Black/White

Item No.: FL2001-R  
Wattage: 15W, Driver: Lifud  
Chip Led: Osram, CRI>90  
Beam Angle: 110°  
Size/Cut hole:  
Φ153\*55mm/Φ145mm  
Color: Black/White

Item No.: FL2001-R  
Wattage: 20W, Driver: Lifud  
Chip Led: Osram, CRI>90  
Beam Angle: 110°  
Size/Cut hole:  
Φ175\*55mm/Φ165mm  
Color: Black/White

- Ultra-thin edge design: Rapidly integrates with the surrounding environment, making it difficult to find the connection between the lamp and the ceiling.
- Perfect Illumination: Deep anti-glare design provide sufficient light for general lighting without glare, bring a cozy and warm ambiance for your sight.
- Modular design: different surface rings for your option. You can DIY the appearance of your lamp whenever you like. What' s more, it will reduce your inventory to reduce risk.
- Reliable Safety: Die-cast aluminum material guarantees corrosion protection and rust prevention. The airtight structure ensure a long-lasting and stable lighting performance .







Item No.: FL2001-S  
Wattage: 9W, Chip Led: Osram,  
Driver: Lifud, CRI>90  
Beam Angle: 110°  
Size/Cut hole:  
110\*110\*50mm/102\*102mm  
Color: Black/White

Item No.: FL2001-S  
Wattage: 15W, Chip Led: Osram,  
Driver: Lifud, CRI>90  
Beam Angle: 110°  
Size/Cut hole:  
145\*145\*55mm/137\*137mm  
Color: Black/White

Item No.: FL2001-S  
Wattage: 20W, Chip Led: Osram,  
Driver: Lifud, CRI>90  
Beam Angle: 110°  
Size/Cut hole:  
170\*170\*55mm/Φ162\*162mm  
Color: Black/White

- Ultra-thin edge design: Rapidly integrates with the surrounding environment, making it difficult to find the connection between the lamp and the ceiling.
- Perfect Illumination: Deep anti-glare design provide sufficient light for general lighting without glare, bring a cozy and warm ambiance for your sight.
- Modular design: different surface rings for your option. You can DIY the appearance of your lamp whenever you like. What' s more, it will reduce your inventory to reduce risk.
- Reliable Safety: Die-cast aluminum material guarantees corrosion protection and rust prevention. The airtight structure ensure a long-lasting and stable lighting performance .



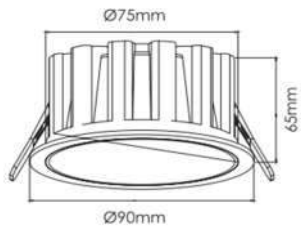

Item No.: FL2002-COB  
Wattage: 7W, Chip Led: Cree,  
Driver: Lifud, CRI>90  
Beam Angle: 110°  
Size/Cut hole:  
Ø94\*64mm/Ø75mm

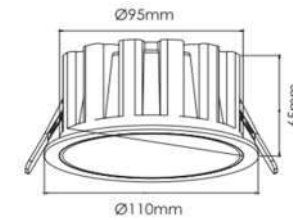

Item No.: FL2002-COB  
Wattage: 12W, Chip Led: Cree,  
Driver: Lifud, CRI>90  
Beam Angle: 110°  
Size/Cut hole:  
Ø114\*68mm/Ø95mm

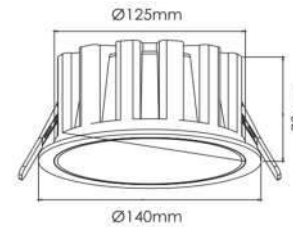

Item No.: FL2002-COB  
Wattage: 20W, Chip Led: Cree,  
Driver: Lifud, CRI>90  
Beam Angle: 110°  
Size/Cut hole:  
Ø140\*74mm/Ø125mm

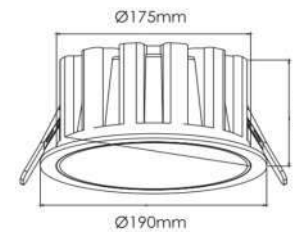

Item No.: FL2002-COB  
Wattage: 30W, Chip Led: Cree,  
Driver: Lifud, CRI>90  
Beam Angle: 110°  
Size/Cut hole:  
Ø184\*80mm/Ø175mm

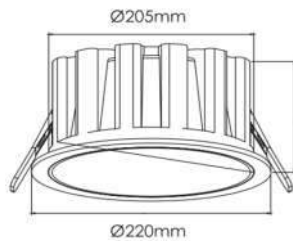

Item No.: FL2002-COB  
Wattage: 40W, Chip Led: Cree,  
Driver: Lifud, CRI>90  
Beam Angle: 110°  
Size/Cut hole:  
Ø184\*80mm/Ø205mm

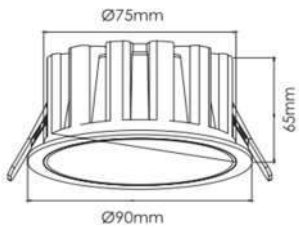
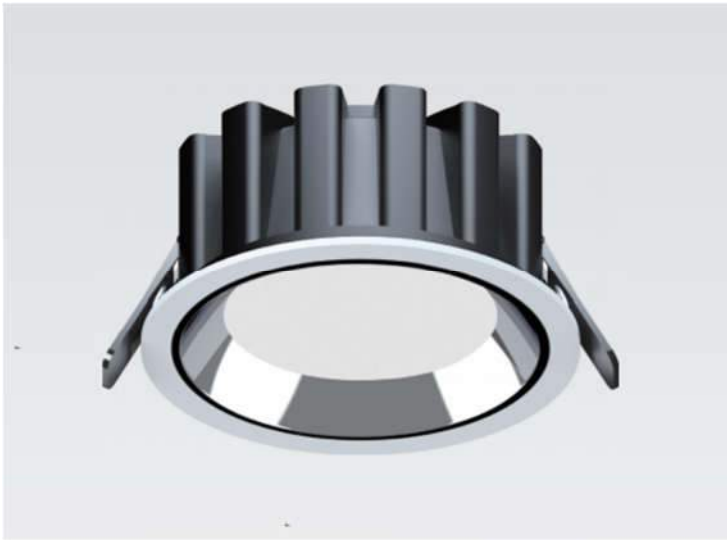

Item No.: FL2002-SMD  
Wattage: 7W, Chip Led: Osram,  
Driver: Lifud, CRI>90  
Beam Angle: 110°  
Size/Cut hole:  
Ø94\*64mm/Ø75mm

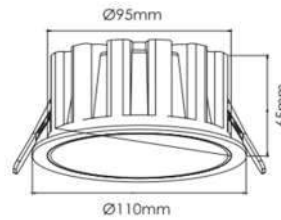

Item No.: FL2002-SMD  
Wattage: 12W, Chip Led: Osram,  
Driver: Lifud, CRI>90  
Beam Angle: 110°  
Size/Cut hole:  
Ø114\*68mm/Ø95mm

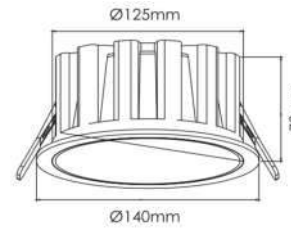

Item No.: FL2002-SMD  
Wattage: 20W, Chip Led: Osram,  
Driver: Lifud, CRI>90  
Beam Angle: 110°  
Size/Cut hole:  
Ø140\*74mm/Ø125mm

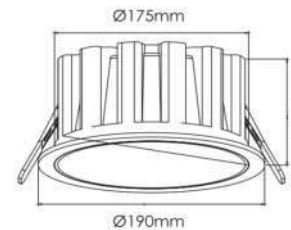

Item No.: FL2002-SMD  
Wattage: 30W, Chip Led: Osram,  
Driver: Lifud, CRI>90  
Beam Angle: 110°  
Size/Cut hole:  
Ø184\*80mm/Ø175mm

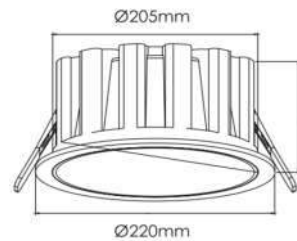

Item No.: FL2002-SMD  
Wattage: 40W, Chip Led: Osram,  
Driver: Lifud, CRI>90  
Beam Angle: 110°  
Size/Cut hole:  
Ø184\*80mm/Ø205mm

Picture



Item No.	FL2003-Reflector	FL2003-Reflector	FL2003-Reflector	FL2003-Reflector	FL2003-Reflector
Wattage	10W	18W	30W	40W	50W
Chip Led	Cree	Cree	Cree	Cree	Cree
Drive	Lifud	Lifud	Lifud	Lifud	Lifud
Size	Φ86*55mm	Φ101*60mm	Φ140*73mm	Φ180*94mm	Φ214*110mm
Cut Hole	Φ75mm	Φ90mm	Φ125mm	Φ165mm	Φ200mm
Beam Angle	50°	24°/38°/55°	24°/38°/55°	24°/38°/55°	24°/38°/55°
CRI	>90	>90	>90	>90	>90

Drawing

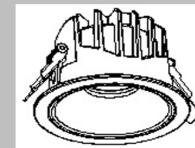
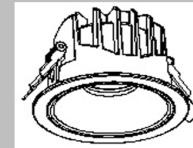
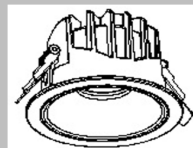
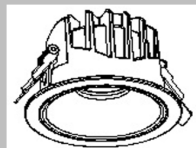
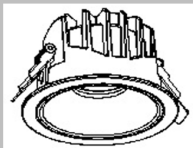

Picture



Item No.	FL2003-LENS	FL2003-LENS	FL2003-LENS	FL2003-LENS
Wattage	10W	18W	30W	35W
Chip Led	Cree	Cree	Cree	Cree
Drive	Lifud	Lifud	Lifud	Lifud
Size	Φ86*55mm	Φ101*60mm	Φ140*73mm	Φ155*86mm
Cut Hole	Φ75mm	Φ90mm	Φ125mm	Φ140mm
Beam Angle	12°/24°/38°/55°	12°/24°/38°/55°	12°/24°/38°/55°	12°/24°/38°/55°
CRI	>90	>90	>90	>90

Drawing

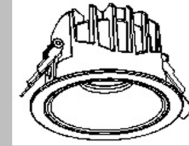
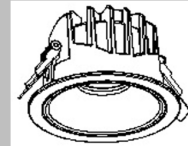
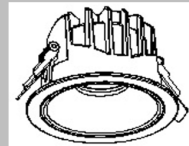
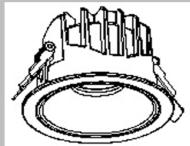

Item No.: FL2004  
Wattage: 7W/12W/18W  
Chip Led: Osram  
Driver: Lifud  
CRI > 90  
Beam Angle: 60°  
CCT: 2700K/3000K/3500K/4000K  
Size/Cut hole:  
Φ83\*50mm/Φ75mm  
Φ108\*63mm/Φ95mm  
Φ123\*74mm/Φ115mm







Item No.: FL2005  
Wattage: 8W/12W/25W/30W  
Chip Led: Osram  
Driver: Lifud  
CRI>90  
Beam Angle: 90°  
CCT: 2700K/3000K/3500K/4000K  
Size/Cut hole:  
Φ110\*34mm/Φ95mm  
Φ145\*36mm/Φ130mm  
Φ180\*38mm/Φ165mm  
Φ230\*210mm/Φ210mm





Item No.: FL2006  
Wattage: 7W/12W/20W/30W  
Chip Led: Osram  
Driver: Lifud, CRI > 90  
Beam Angle: 90°  
CCT: 2700K/3000K/3500K/4000K  
Size/Cut hole:  
Φ88\*46mm/Φ75mm  
Φ105\*60/Φ90mm  
Φ130\*68/Φ110mm  
Φ185\*93/Φ165mm  
Φ220\*98/Φ195mm





Item No.: FL2007  
Wattage: 7W/12W/18W/24W/30W/40W  
Chip Led: Cree  
Driver: Lifud  
CRI>90  
Beam Angle: 40°  
CCT: 2700K/3000K/3500K/4000K  
Size/Cut hole:  
Φ90\*50mm/Φ75mm  
Φ102\*60mm/Φ90mm  
Φ142\*82mm/Φ125mm  
Φ175\*95mm/Φ145mm  
Φ200\*110mm/Φ165mm  
Φ230\*125mm/Φ190mm



- **Reliable Material:** Die-cast aluminum material not only guarantees corrosion protection and rust prevention, but improves the heat dissipation efficiency.
- **Perfect Illumination:** Deep anti-glare design provide sufficient light for general lighting without glare, bring a cozy and warm ambiance for your sight.
- **large wattage:** External constant current isolated driver, easily connected by male and female plugs, release the limit of wattage. The range of wattage for your option up to 40W.



Item No.: FL2008  
Wattage: 10W/15W/20W/30W/40W  
Chip Led: Cree  
Driver: Lifud  
CRI>90  
Beam Angle: 60°  
CCT: 2700K/3000K/3500K/4000K  
Size/Cut hole:  
Φ87\*33mm/Φ80mm  
Φ115\*42mm/Φ105mm  
Φ142\*50mm/Φ130mm  
Φ169\*58mm/Φ155mm  
Φ217\*H70mm/Φ200mm

- **Reliable Material:**Die-cast aluminum material not only guarantees corrosion protection and rust prevention, but improves the heat dissipation efficiency.
- **Space-saving Solution:** Ultra-thin LED recessed ceiling light, high brightness. Only requires 30mm clearance of ceiling space, perfect solution for your narrow ceiling that doesn't fit for a can.
- **large wattage:** External constant current isolated driver, easily connected by male and female plugs, release the limit of wattage. The range of wattage for your option up to 40W.





Wattage: 3W/5W/8W  
Chip Led: Cree  
Driver: Lifud  
CRI > 90  
Beam Angle: 15°/25°/36°  
CCT: 2700K/3000K/3500K/4000K  
Size/Cut hole:  
Φ38\*39mm/Φ30mm  
Φ57\*67mm/Φ50mm  
Φ70\*79mm/Φ60mm

- **Reliable Safety:** Aluminum material guarantees corrosion protection and rust prevention. The airtight structure ensure a long-lasting and stable lighting performance.
- **Cost-saving:** Photoelectric integration design, simplify structure to reduce useless costs.
- **Long lifespan:** aluminum alloy housing for better dissipation for longevity up to 20000 hours . High performance, modern round design apply to different commercial lighting area.
- **Wonderful design:** it makes different shape on your ceiling,DIY

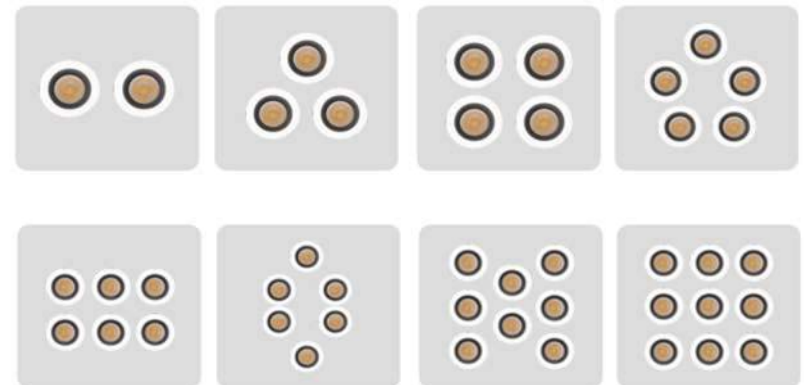





Item No.: FL3001-Adjustable  
Wattage: 3W/5W/8W  
Chip Led: Cree  
Driver: Lifud  
CRI>90  
Beam Angle: 15°/25°/36°  
CCT: 2700K/3000K/3500K/4000K  
Size/Cut hole:  
Φ45\*54mm/Φ40mm  
Φ57\*75mm/Φ50mm  
Φ68\*85mm/Φ60mm

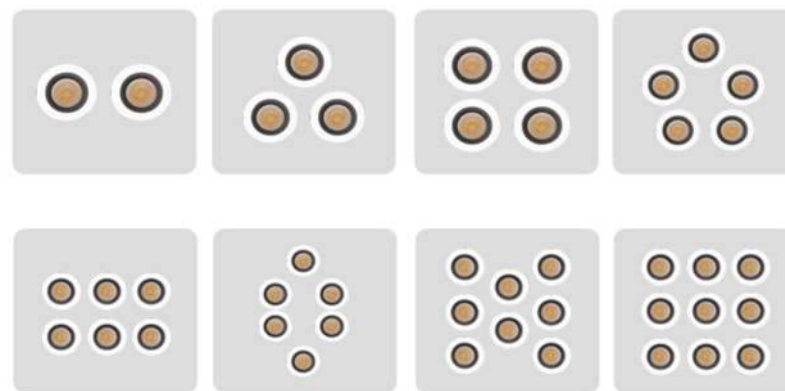





Item No.: FL3002  
Wattage: 3W  
Chip Led: Cree  
Driver: Lifud  
CRI>90  
Beam Angle: 15°/25°/40°  
CCT: 2700K/3000K/3500K/4000K  
Size/Cut hole:  
Φ40\*28mm/Φ35mm

- **Reliable Safety:** Aluminum material guarantees corrosion protection and rust prevention. The airtight structure ensure a long-lasting and stable lighting performance.
- **Cost-saving:** Photoelectric integration design, simplify structure to reduce useless costs.
- **Long lifespan:** aluminum alloy housing for better dissipation for longevity up to 20000 hours . High performance, modern round design apply to different commercial lighting area.
- **Wonderful design:** it makes different shape on your ceiling, DIY





Item No.: FL3003  
Wattage: 3W  
Chip Led: Cree  
Driver: Lifud  
CRI>90  
Beam Angle: 15°/25°/40°  
CCT: 2700K/3000K/3500K/4000K  
Size/Cut hole:  
Φ50\*28mm/Φ45mm

- **Reliable Safety:** Aluminum material guarantees corrosion protection and rust prevention. The airtight structure ensure a long-lasting and stable lighting performance.
- **Cost-saving:** Photoelectric integration design, simplify structure to reduce useless costs.
- **Long lifespan:** aluminum alloy housing for better dissipation for longevity up to 20000 hours . High performance, modern round design apply to different commercial lighting area.
- **Wonderful design:** it makes different shape on your ceiling, DIY



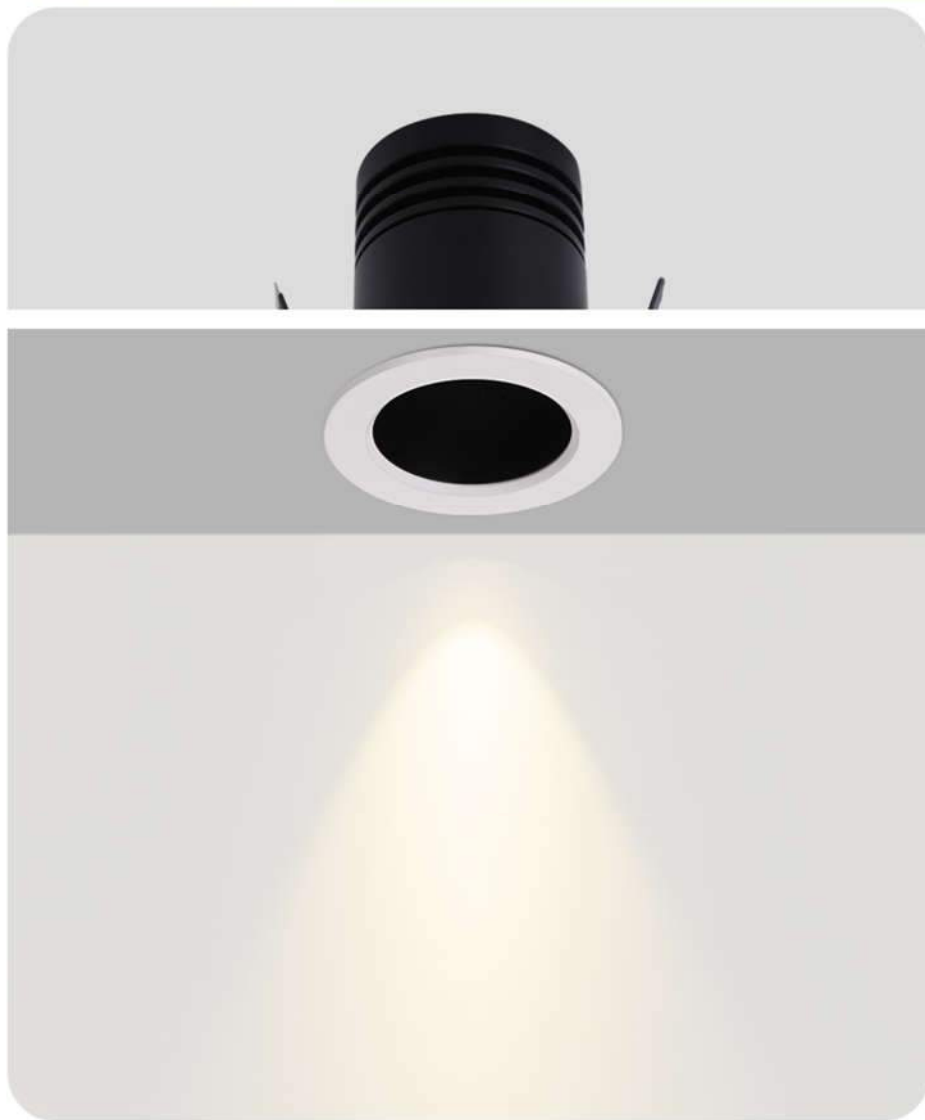

Item No.: FL3004  
Wattage: 3W/5W/8W  
Chip Led: Cree  
Driver: Lifud  
CRI>90  
Beam Angle: 15°/25°/36°  
CCT: 2700K/3000K/3500K/4000K  
Size/Cut hole:  
Φ35\*45mm/Φ30mm  
Φ55\*61mm/Φ50mm





Item No.: FL4001  
Wattage: 10W/18W/30W  
Beam Angle: 10°  
Chip Led: Cree, Driver: Lifud, CRI > 90  
CCT: 2700K/3000K/3500K/4000K  
Size/Cut hole:  
Φ85\*70mm/Φ75mm  
Φ108\*85mm/Φ95mm  
Φ135\*97mm/Φ125mm



- **Reliable Material:**Die-cast aluminum material not only guarantees corrosion protection and rust prevention, but improves the heat dissipation efficiency.
- **Perfect Illumination:** Deep anti-glare design provide sufficient light for general lighting without glare, bring a cozy and warm ambiance for your sight.
- **Space-saving Solution:** Ultra-thin LED recessed ceiling light, high brightness. Only requires 30mm clearance of ceiling space , perfect solution for your narrow ceiling that doesn' t fit for a can.

Item No.: FL5001  
Wattage: 10W/2\*10W/3\*10W  
Chip Led: Cree, Driver: Lifud, CRI>90  
Beam Angle: 15°/24°/38°/60°  
CCT: 2700K/3000K/3500K/4000K  
Size/Cut hole:  
115\*115\*70mm/100\*100mm  
230\*115\*70mm/215\*100mm  
350\*115\*70mm/335\*100mm  
Item No.: FL5001

Wattage: 18W/2\*18W/3\*18W  
Chip Led: Cree, Driver: Lifud, CRI>90  
Beam Angle: 15°/24°/38°/60°  
CCT: 2700K/3000K/3500K/4000K  
Size/Cut hole:  
138\*138\*90mm/125x125mm  
278x138\*90mm/263x125mm  
417\*138\*90mm/400x125mm  
Item No.: FL5001

Wattage: 30W/2\*30W/3\*30W  
Chip Led: Cree, Driver: Lifud, CRI>90  
Beam Angle: 15°/24°/38°/60°  
CCT: 2700K/3000K/3500K/4000K  
Size/Cut hole:  
163x163\*100mm/150x150mm  
330x163\*100mm/315x150mm  
495x163\*100mm/480x150mm



Item No.: FL5002-Reflector  
Wattage: 12W/2\*12W/3\*12W  
Chip Led: Cree, Driver: Lifud, CRI>90  
Beam Angle: 15°/24°/38°/60°  
CCT: 2700K/3000K/3500K/4000K  
Size/Cut hole:  
115x115\*95mm/100x100mm  
230x115\*95mm/215x100mm  
350x115\*95mm/335x100mm

Item No.: FL5002-Reflector  
Wattage: 20W/2\*20W/3\*20W  
Chip Led: Cree, Driver: Lifud, CRI>90  
Beam Angle: 15°/24°/38°/60°  
CCT: 2700K/3000K/3500K/4000K  
Size/Cut hole:  
138x138\*125mm/125x125mm  
278x138\*125mm/263x125mm  
417x138\*125mm/400x125mm

Item No.: FL5002-Reflector  
Wattage: 30W/2\*30W/3\*30W  
Chip Led: Cree, Driver: Lifud, CRI>90  
Beam Angle: 15°/24°/38°/60°  
CCT: 2700K/3000K/3500K/4000K  
Size/Cut hole:  
163x163\*145mm/150x150mm  
330x163\*145mm/315x150mm  
495x163\*145mm/480x150mm



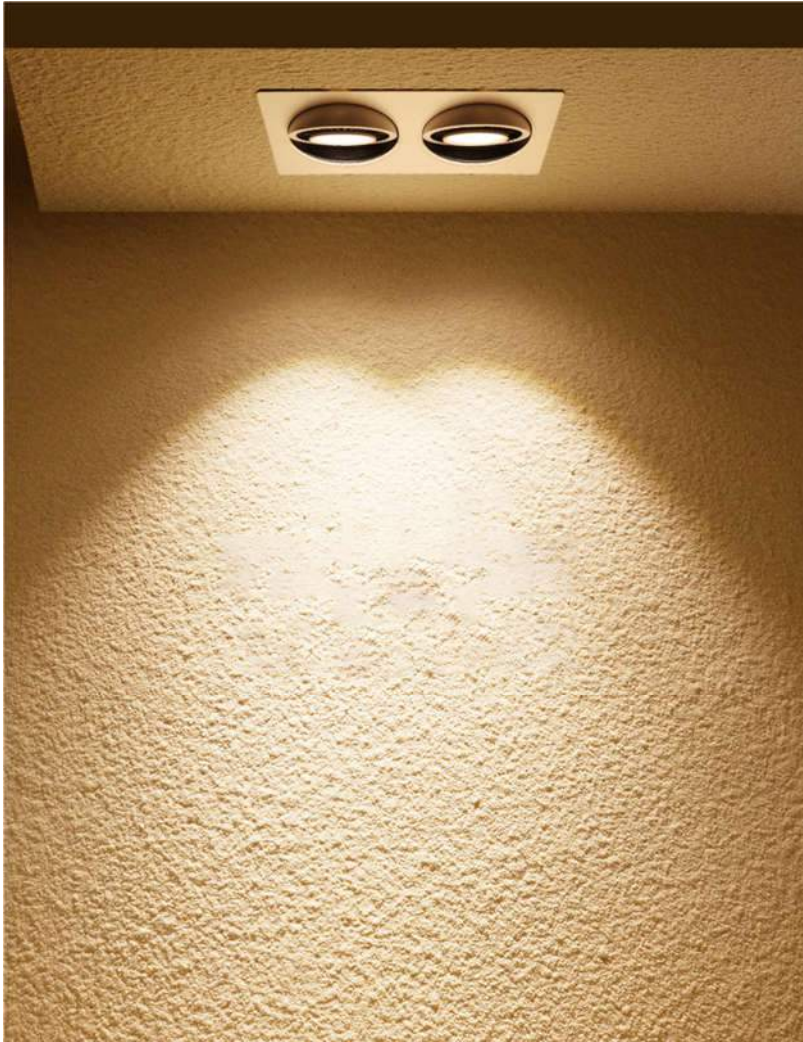

Item No.: FL5002-LENS  
Wattage: 12W/2\*12W/3\*12W  
Chip Led: Cree, Driver: Lifud, CRI>90  
Beam Angle: 10°/23°/36  
CCT: 2700K/3000K/3500K/4000K  
Size/Cut hole:  
115x115\*95mm/100x100mm  
230x115\*95mm/215x100mm  
350x115\*95mm/335x100mm

Item No.: FL5002-LENS  
Wattage: 20W/2\*20W/3\*20W  
Chip Led: Cree, Driver: Lifud, CRI>90  
Beam Angle: 10°/23°/36  
CCT: 2700K/3000K/3500K/4000K  
Size/Cut hole:  
138x138\*125mm/125x125mm  
278x138\*125mm/263x125mm  
417x138\*125mm/400x125mm

Item No.: FL5002-LENS  
Wattage: 30W/2\*30W/3\*30W  
Chip Led: Cree, Driver: Lifud, CRI>90  
Beam Angle: 10°/23°/36  
CCT: 2700K/3000K/3500K/4000K  
Size/Cut hole:  
163x163\*145mm/150x150mm  
330x163\*145mm/315x150mm  
495x163\*145mm/480x150mm



Item No.: FL5003  
Wattage: 7W/2\*7W/3\*7W  
Chip Led: Cree, Driver: Lifud, CRI>90  
Beam Angle: 15°/24°/36°/45°/60°  
CCT: 2700K/3000K/3500K/4000K  
Size/Cut hole:  
73\*73\*70mm/65\*65mm  
132\*73\*H70mm/125\*65mm  
192\*73\*H70mm/185\*65mm  
Item No.: FL5003

Wattage: 12W/2\*12W/3\*12W  
Chip Led: Cree, Driver: Lifud, CRI>90  
Beam Angle: 15°/24°/36°  
CCT: 2700K/3000K/3500K/4000K  
Size/Cut hole:  
100\*100\*72mm/90\*90mm  
100\*185\*72mm/175\*90mm  
100\*270\*72mm/260\*90mm  
Item No.: FL5003

Wattage: 20W/2\*20W/3\*20W  
Chip Led: Cree, Driver: Lifud, CRI>90  
Beam Angle: 15°/24°/36°  
CCT: 2700K/3000K/3500K/4000K  
Size/Cut hole:  
130\*130\*H110mm/120\*120mm  
130\*240\*110mm/120\*230mm  
130\*345\*H110mm/120\*335mm





Item No.: FL5004-Single  
Wattage: 10W/20W/30W/40W  
Chip Led: Cree, Driver: Lifud, CRI>90  
Beam Angle: 15°/24°/38°/45°/60°  
CCT: 2700K/3000K/3500K/4000K

Size/Cut hole:

115\*115\*124mm/100\*100mm  
140\*140\*139mm/125\*125mm  
160\*160\*143mm/145\*145mm  
180\*180\*143mm/165\*165mm



Item No.: FL5004-Double

Wattage: 2\*10W/2\*20W/2\*30W/2\*40W  
Chip Led: Cree, Driver: Lifud, CRI>90  
Beam Angle: 15°/24°/38°/45°/60°  
CCT: 2700K/3000K/3500K/4000K

Size/Cut hole:

215\*116\*124mm/200\*100mm  
265\*140\*139mm/250\*125mm  
300\*160\*143mm/290\*145mm  
345\*180\*143mm/330\*165mm



Item No.: FL5004-Triple

Wattage: 3\*10W/3\*20W/3\*30W/3\*40W  
Chip Led: Cree, Driver: Lifud, CRI>90  
Beam Angle: 15°/24°/38°/45°/60°  
CCT: 2700K/3000K/3500K/4000K

Size/Cut hole: 315\*115\*124mm/300\*100mm  
390\*140\*139mm/375\*125mm  
450\*160\*143mm/440\*145mm  
505\*180\*143mm/485\*165mm





Item No.: FL5005  
Wattage: 10W/2\*10W/3\*10W  
Beam Angle: 15°/30°/45°  
Chip Led: Cree  
Driver: Lifud  
CRI>90  
CCT: 2700K/3000K/3500K/4000K  
Size/Cut hole:  
97\*97\*86mm/80\*80mm  
166\*97\*867mm/148\*80mm  
236\*97\*86mm/218\*80mm

- **Reliable Material:**Die-cast aluminum material not only guarantees corrosion protection and rust prevention, but improves the heat dissipation efficiency.
- **Perfect Illumination:** Deep anti-glare design provide sufficient light for general lighting without glare, bring a cozy and warm ambiance for your sight.
- **Space-saving Solution:** Ultra-thin LED recessed ceiling light, high brightness. Only requires 30mm clearance of ceiling space , perfect solution for your narrow ceiling that doesn' t fit for a can.





Item No.: FL6001  
Wattage: 5W/9W/12W/15W  
Chip Led: Cree  
Driver: Lifud  
CRI>90  
Beam Angle: 120°  
CCT: 2700K/3000K/3500K/4000K  
Size/Cut hole:  
Φ83\*42mm/Φ75mm  
Φ100\*48mm/Φ95mm  
Φ133\*63mm/Φ120mm  
Φ167\*68mm/Φ145mm

- **Reliable Material:**Die-cast aluminum material not only guarantees corrosion protection and rust prevention, but improves the heat dissipation efficiency.
- **Option of performance:** 4 kind of different surface-rings for your choice, aiming at meeting your different request at same time.
- **Equipping with imported high CRI light source,** different beam angles design meet different requirements.
- **Bring sunlight indoor - Highlight your home decorate with more vivid and sun-like quality lighting with CRI90+ to create a cozy atmosphere.**



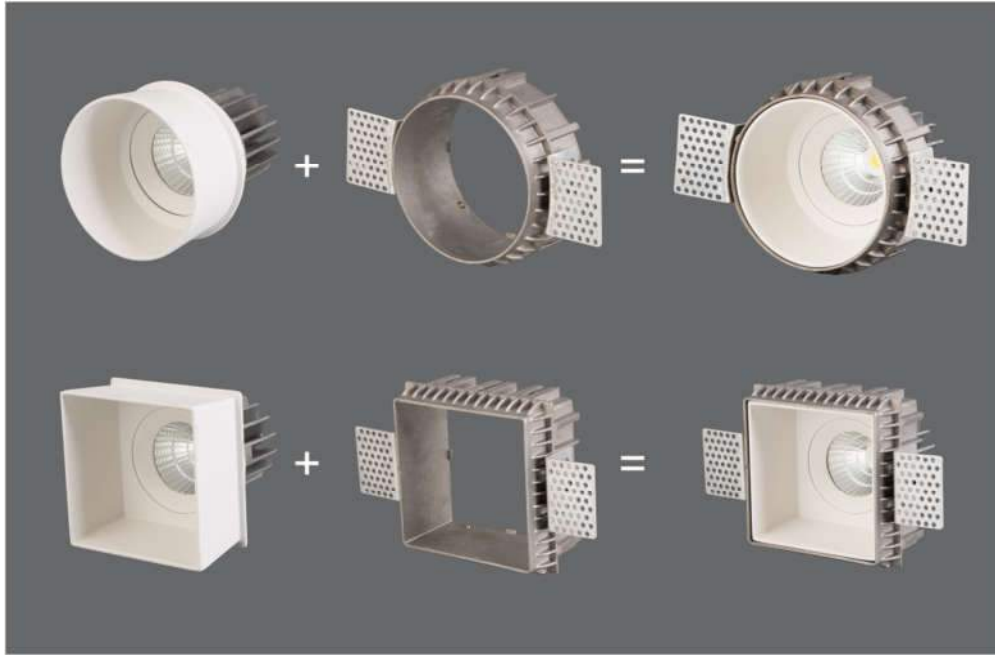

Item No.: FL6002-S  
Wattage:9W  
Chip Led: Cree  
Driver: Lifud  
CRI>90  
Beam Angle: 15°/24°/38°  
CCT: 2700K/3000K/3500K/4000K  
Size/Cut hole:  
95\*95\*103mm/100\*100mm

Item No.: FL6002-R  
Wattage:9W  
Chip Led: Cree  
Driver: Lifud  
CRI>90  
Beam Angle: 15°/24°/38°  
CCT: 2700K/3000K/3500K/4000K  
Size/Cut hole:  
Φ95\*103mm/Φ100mm





Item No.: FL7001  
Wattage: 9W/15W  
Chip Led: Cree  
Driver: Done  
CRI > 90  
Beam Angle: 15°/24°/36°  
CCT: 2700K/3000K/3500K/4000K  
Size/Cut hole:  
Φ72\*H80mm/Φ 62mm  
Φ92\*H93mm/Φ 80mm  
IP Rating: IP54





Item No.: FL7002

Wattage:10W,Chip Led: Cree,Driver: Lifud,  
CRI>90

Beam Angle: 24°/38°

CCT: 2700K/3000K/3500K/4000K

Size/Cut hole:

Φ90\*90mm/Φ75mm

IP Raiting: IP65



Item No.: FL8001  
Wattage:10W/15W/18W/25W/40W/50W/80W  
Chip Led: Cree,Driver: Done, CRI>90  
Beam Angle: 20°/40°  
IP Raiting: IP65  
CCT: 2700K/3000K/3500K/4000K  
Size:  $\Phi 75 \times 100 \text{mm}$   
 $\Phi 75 \times 152 \text{mm}$   
 $\Phi 95 \times 100 \text{mm}$   
 $\Phi 95 \times 152 \text{mm}$   
 $\Phi 115 \times 152 \text{mm}$   
 $\Phi 140 \times 162 \text{mm}$   
 $\Phi 170 \times 182 \text{mm}$   
 $\Phi 205 \times 212 \text{mm}$





Item No.: FL8002

Wattage:10W/15W/15W/20W/30W

Chip Led: Cree,Driver: Done, CRI> 90

Beam Angle: 20°/40°

IP Rating: **IP65**

CCT: 2700K/3000K/3500K/4000K

Size:75\*100mm

75\*152mm

95\*100mm

95\*152mm

115\*152mm

Picture





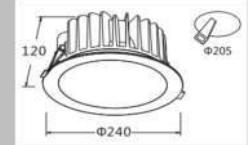
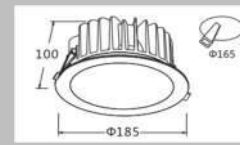
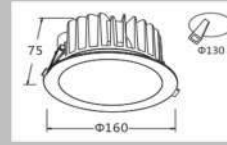
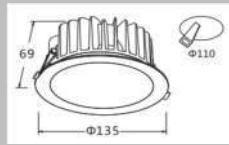
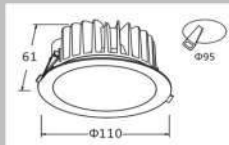

Item No.	FL9001-COB	FL9001-COB	FL9001-COB	FL9001-COB	FL9001-COB
Wattage	9W	15W	20W	35W	50W
Chip Led	Cree	Cree	Cree	Cree	Cree
Driver	Lifud	Lifud	Lifud	Lifud	Lifud
Size	Φ110*65mm	Φ135*72mm	Φ160*75mm	Φ195*107mm	Φ235*127mm
Cut Hole	Φ95mm	Φ110mm	Φ130mm	Φ170mm	Φ200mm
Beam Angle	50°	50°	50°	50°	50°
CRI	>80/90	>80/90	>80/90	>80/90	>80/90

Drawing



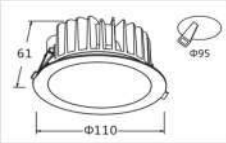
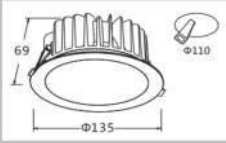
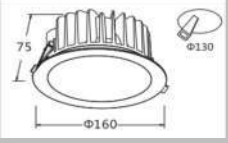
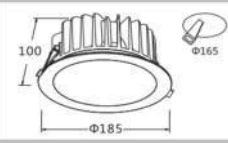
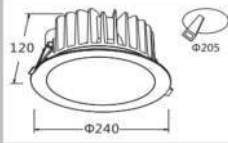

Picture					
Item No.	FL9001-SMD	FL9001-SMD	FL9001-SMD	FL9001-SMD	FL9001-SMD
Wattage	10W	18W	25W	40W	50W
Chip Led	Osram	Osram	Osram	Osram	Osram
Driver	Lifud	Lifud	Lifud	Lifud	Lifud
Size	Φ110*65mm	Φ135*72mm	Φ160*75mm	Φ195*107mm	Φ235*127mm
Cut Hole	Φ95mm	Φ110mm	Φ130mm	Φ170mm	Φ200mm
Beam Angle	110°	110°	110°	110°	110°
CRI	>80/90	>80/90	>80/90	>80/90	>80/90
Drawing					





Item No.: FL-A001  
Wattage:12W/20W/30W  
Chip Led: Cree  
Driver: CE  
CRI>90  
Beam Angle: ZOOM 15°-60°  
CCT: 2700K/3000K/3500K/4000K  
Size:  
73\*104mm  
88\*110mm  
100\*116mm



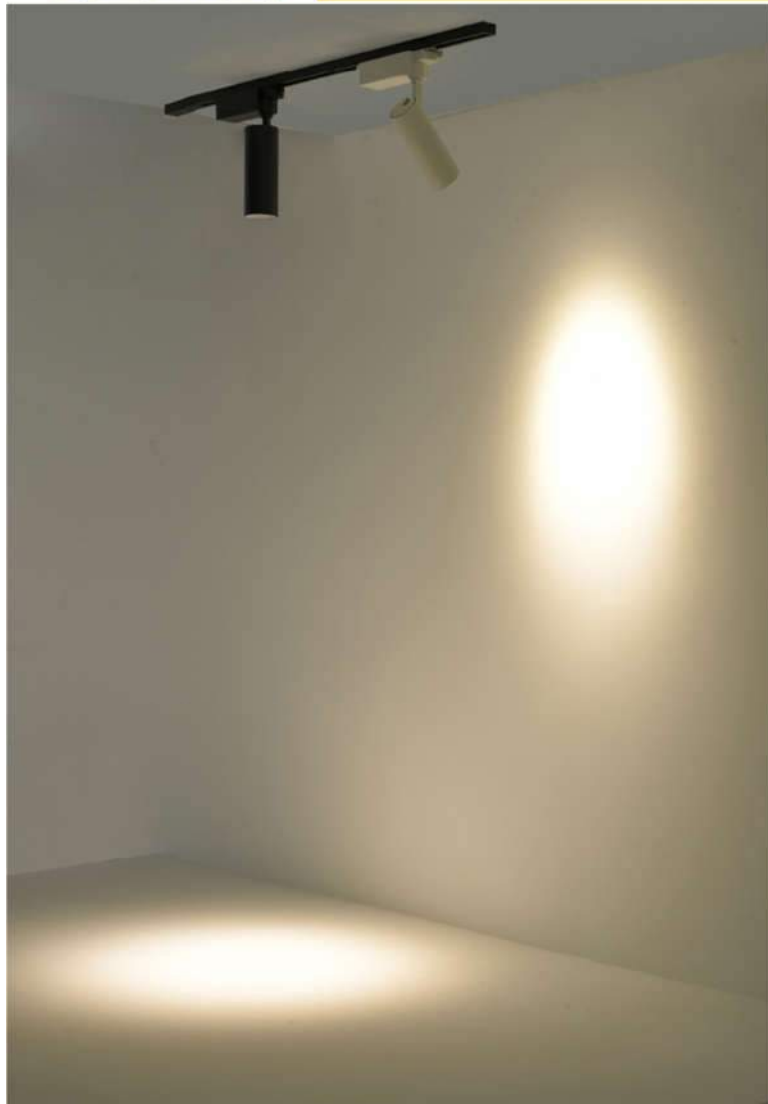

Item No.: FL-A002

Wattage: 12W/15W/20W/25W/30W/35W

Chip Led: Cree

Driver: CE

CRI > 90

Beam Angle: 15°/24°/38°

CCT: 2700K/3000K/3500K/4000K

Size:  $\Phi 50 \times H 130 \text{mm}$

$\Phi 60 \times H 134 \text{mm}$

$\Phi 70 \times H 145 \text{mm}$

$\Phi 74 \times H 140 \text{mm}$

$\Phi 78 \times H 150 \text{mm}$

$\Phi 90 \times H 140 \text{mm}$



Item No.: FL-A003  
Wattage:10W/20W/30W  
Chip Led: Cree  
Driver: CE  
CRI>90  
Beam Angle: 15°/24°/38°  
CCT: 2700K/3000K/3500K/4000K  
Size:  
Φ60\*H100mm  
Φ80\*H120mm  
Φ90\*H140mm



Item No.: FL-B001-R  
Wattage:9W/15W25W35W45W  
Chip Led: Cree  
Driver: CE  
CRI>90  
Beam Angle: 60°  
CCT: 2700K/3000K/3500K/4000K  
Size:  
Φ90\*90mm  
Φ110\*120mm  
Φ130\*152mm  
Φ170\*185mm  
Φ193\*193mm





Item No.: FL-B001-S  
Wattage: 9W/20W/30W/40W  
Chip Led: Cree  
Driver: CE  
CRI > 90  
Beam Angle: 60°  
CCT: 2700K/3000K/3500K/4000K  
Size:  
90\*90\*90mm  
110\*110\*120mm  
130\*130\*132mm  
160\*160\*165mm





Item No.: FL-B002-R  
Wattage:9W/15W/25W/35W/45W  
Chip Led: Cree  
Driver: CE  
CRI>90  
Beam Angle: 20°/45°  
CCT: 2700K/3000K/3500K/4000K  
Size:  
Φ90\*H90mm  
Φ110\*H120mm  
Φ130\*H152mm  
Φ170\*H185mm  
Φ195\*H195mm







Item No.: FL-B002-S  
Wattage:9W/15W/25W/35W/45W  
Chip Led: Cree  
Driver: CE  
CRI>90  
Beam Angle: 20°/45°  
CCT: 2700K/3000K/3500K/4000K  
Size:  
90\*90\*H90mm  
110\*110\*H120mm  
130\*130\*H135mm  
160\*160\*H165mm



Item No.: FL-B003-R  
Wattage:10W  
Chip Led: Cree  
Driver: CE  
CRI>90  
Beam Angle: 12°/24°/36°  
CCT:  
2700K/3000K/3500K/4000K  
Size: Φ79\*H110mm



Item No.: FL-B003-S  
Wattage:10W  
Chip Led: Cree  
Driver: CE  
CRI>90  
Beam Angle: 12°/24°/36°  
CCT:  
2700K/3000K/3500K/4000K  
Size: 79\*79\*H110mm



Item No.: FL-B004-R  
Wattage:10W  
Chip Led: Cree  
Driver: CE  
CRI>90  
Beam Angle: 24°/36°  
CCT:  
2700K/3000K/3500K/4000K  
Size: Φ80\*100mm



Item No.: FL-B004-S  
Wattage:8W  
Chip Led: Cree  
Driver: CE  
CRI>90  
Beam Angle: 24°/36°  
CCT:  
2700K/3000K/3500K/4000K  
Size: Φ80\*100mm



Item No.: FL-B005  
Wattage:5W  
Chip Led: Cree  
Driver: CE  
CRI>90  
Beam Angle: 24°  
CCT:  
2700K/3000K/3500K/4000K  
Size: Φ65\*70mm



Item No.: FL-B005  
Wattage:9W  
Chip Led: Cree  
Driver: CE  
CRI>90  
Beam Angle: 24°  
CCT:  
2700K/3000K/3500K/4000K  
Size: Φ85\*80mm



Item No.: FL-B006-R  
Wattage: 7W/12W/15W/18W/25W/35W  
Chip Led: Cree, Driver: CE, CRI > 90  
White/Black+Chrome/Black  
Beam Angle: 15°/24°/36°  
CCT: 2700K/3000K/3500K/4000K  
Size:  
Φ55\*100mm  
Φ75\*130mm  
Φ95\*140mm  
Φ115\*160mm  
Φ140\*170mm  
Φ170\*180mm







Item No.: FL-B006-S  
Wattage:7W/12W/18W/25W  
Chip Led: Cree, Driver: CE, CRI>90  
White/Black+Chrome/Black  
Beam Angle: 15°/24°/36°  
CCT: 2700K/3000K/3500K/4000K  
Size:  
55\*55\*120mm  
75\*75\*140mm  
95\*95\*150mm  
115\*115\*160mm







Item No.: FL-B006-DS  
Wattage:7W/12W  
Chip Led: Cree, Driver: CE, CRI>90  
White/Black+Chrome/Black  
Beam Angle: 15°/24°/36°  
CCT: 2700K/3000K/3500K/4000K  
Size:  
55\*110\*120mm  
75\*150\*140mm  
95\*95\*150mm  
115\*115\*160mm





Item No.: FL-B007  
Wattage:10W/20W/30W  
Chip Led: Cree, Driver: CE, CRI>90  
White/Black+Chrome/Black  
Beam Angle: 12°/24°/38°/55°  
CCT: 2700K/3000K/3500K/4000K  
Size:  
Φ75\*90mm  
Φ91\*112mm  
Φ128\*137mm





Item No.: FL-B008  
Wattage: 7W/2\*7W/3\*7W  
10W/2\*10W/3\*10W  
12W/2\*12W/3\*12W  
Chip Led: Cree, Driver: CE, CRI>90  
White/Black  
Beam Angle: 15°/24°/36°  
CCT: 2700K/3000K/3500K/4000K  
Size:  
100\*100\*100mm  
200\*100\*100mm  
300\*100\*100mm

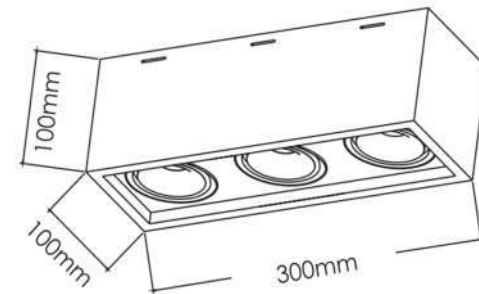
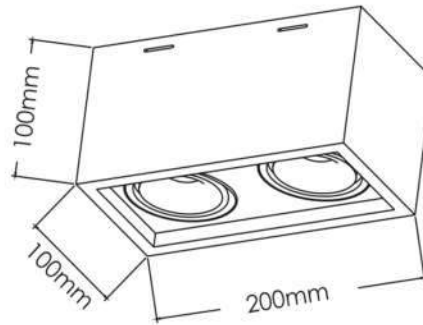
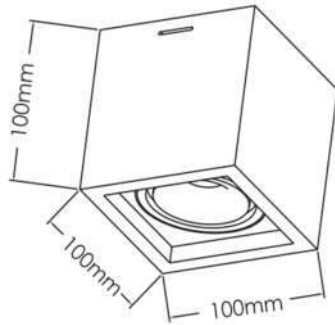



Item No.: FL-B009  
Wattage: 7W/9W  
Chip Led: Osram, Driver: CE, CRI > 90  
White/Black  
Beam Angle: 24°  
CCT: 2700K/3000K/3500K/4000K  
Size:  
Φ95\*40mm  
Φ110\*40mm







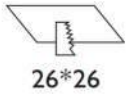

26\*26

FL-C1 1W

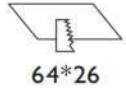
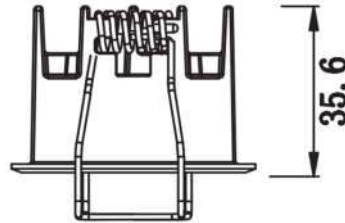
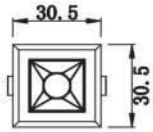

64\*26

FL-C3 3W

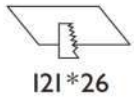
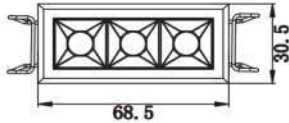

121\*26

FL-C6 6W

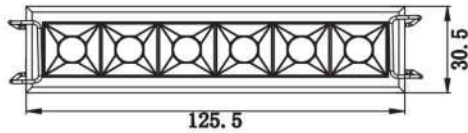

Wattage:1w,3w,6w,12w  
Wattage:4w,9w,16w,25w  
Chip Led: Osram  
Driver: CE  
CRI>90  
Beam Angl: 15°/ 24°/38°  
White+Grey  
CCT:2700K/3000K/4000K

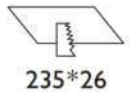

235\*26

FL-C12 12W

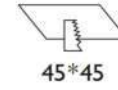
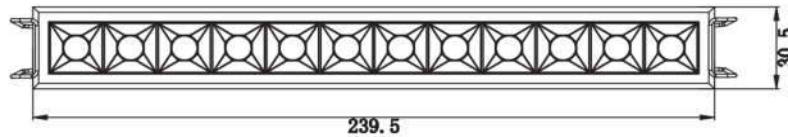

45\*45

FL-C4 4W

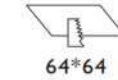
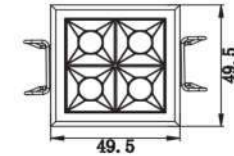

64\*64

FL-C9 9W

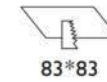
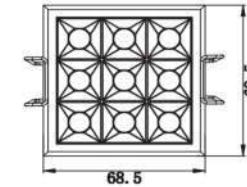

83\*83

FL-C16 16W

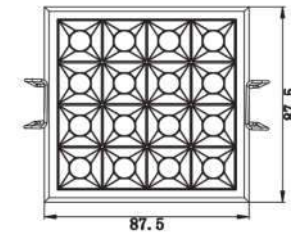

101.5\*101.5

FL-C25 25W

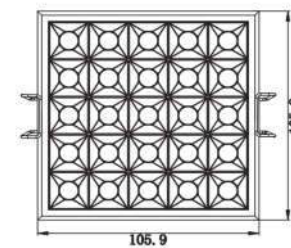



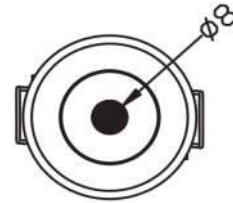

Item No.: FL-C001-R  
 Wattage: 2W/4W  
 Chip Led: Cree, Driver: Lifud, CRI>90  
 Beam Angle: 30°  
 CCT: 2700K/3000K/3500K/4000K  
 Size:  $\Phi 40 \times 32\text{mm} / \Phi 35\text{mm}$   
 $\Phi 55 \times 43\text{mm} / \Phi 50\text{mm}$

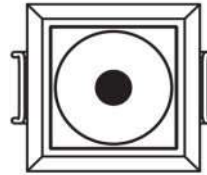

Item No.: FL-C001-Single  
 Wattage: 2W  
 Chip Led: Cree, Driver: Lifud, CRI>90  
 Beam Angle: 30°  
 CCT: 2700K/3000K/3500K/4000K  
 Size:  $40 \times 40 \times 42.2\text{mm} / 35 \times 35\text{mm}$

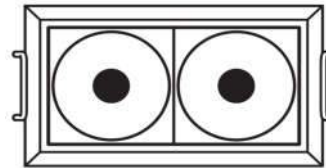

Item No.: FL-C001-Double  
 Wattage: 4W  
 Chip Led: Cree, Driver: Lifud, CRI>90  
 Beam Angle: 30°  
 CCT: 2700K/3000K/3500K/4000K  
 Size:  $69 \times 40 \times 42.2\text{mm} / 65 \times 35\text{mm}$

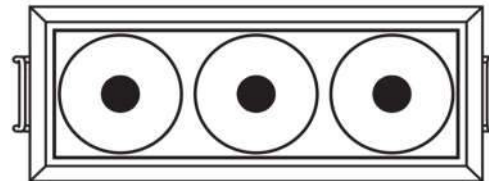

Item No.: FL-C001-Triple  
 Wattage: 6W  
 Chip Led: Cree, Driver: Lifud, CRI>90  
 Beam Angle: 30°  
 CCT: 2700K/3000K/3500K/4000K  
 Size:  $100 \times 40 \times 42.2\text{mm} / 95 \times 35\text{mm}$



Item No.: FL-M1  
Wattage: 7W/12W  
Chip Led: Cree, Driver: Lifud, CRI > 90  
Beam Angle: 12°/24°/36°/60°  
CCT: 2700K/3000K/3500K/4000K  
Size/Cut hole:  
Φ50\*70mm  
Φ50\*86mm

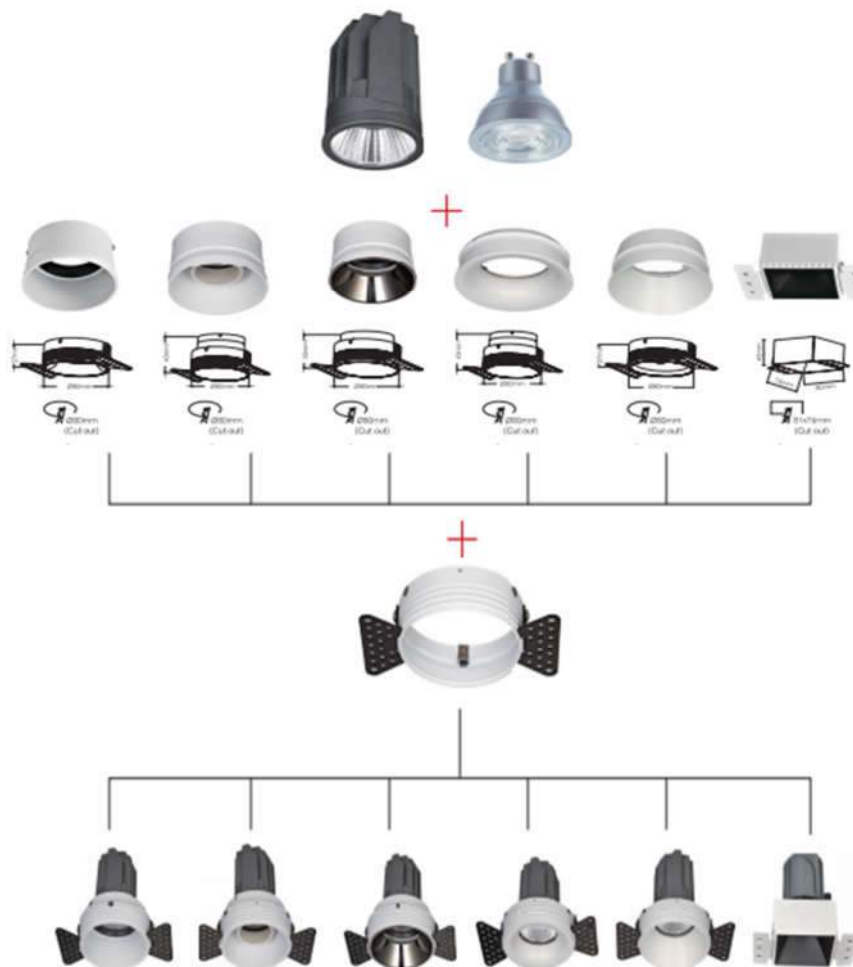



Item No.: FL-M2  
 Wattage: 7W/15W  
 Chip Led: Cree, Driver: Lifud, CRI > 90  
 Beam Angle: 12°/24°/36°/60°  
 CCT: 2700K/3000K/3500K/4000K  
 Size/Cut hole:  
 Φ50\*67mm  
 Φ50\*78mm

